

S310148 Replacement Part - Hero Premium Comfy Lite Hand Grip Pair

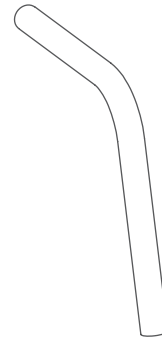

S310149 Replacement Part - Hero Premium Comfy Lite Handle Bar Universal Each (Without Brake & Hand Grip)

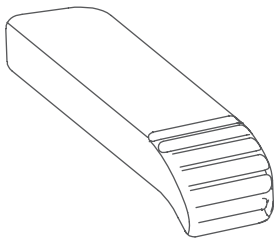

S310150 Replacement Part - Hero Premium Comfy Lite Arm Pad Right

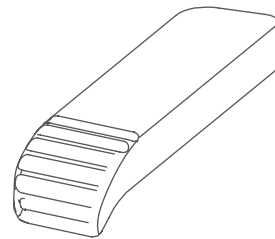

S310151 Replacement Part - Hero Premium Comfy Lite Arm Pad Left

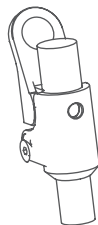

S310152 Replacement Part - Hero Premium Comfy Lite Half Folding Lever Assembly For Backrest Universal Each

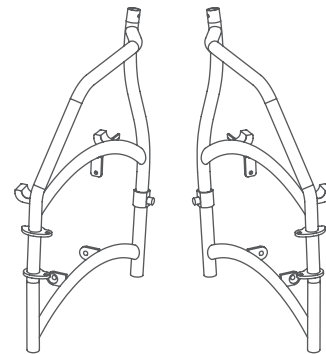

S310153 Replacement Part - Hero Premium Comfy Lite Full Wheelchair Base Frame Transit

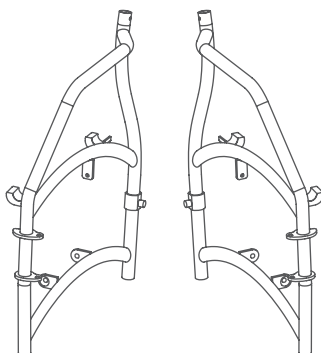

S310154 Replacement Part - Hero Premium Comfy Lite Full Wheelchair Base Frame Self Propelling

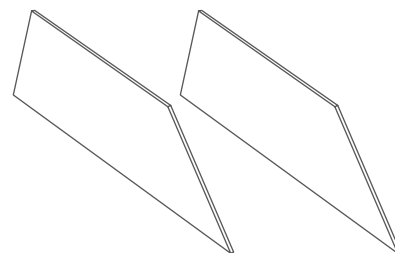

S310155 Replacement Part - Hero Premium Comfy Lite Armrest Fabric Skirt Pair

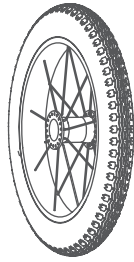

S310156 Replacement Part - Hero Premium Comfy Lite 13" Rear Transit Wheel Universal Each



S310157 Replacement Part - Hero Premium Comfy Lite 22" Rear Self Propelling Wheel Universal Each

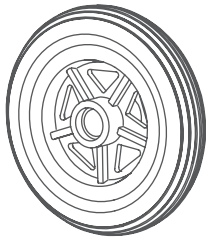

S310160 Replacement Part - Hero Premium Comfy Lite 6" Front Castor Each

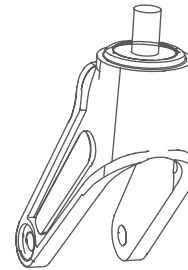

S310161 Replacement Part - Hero Premium Comfy Lite Front Fork Each

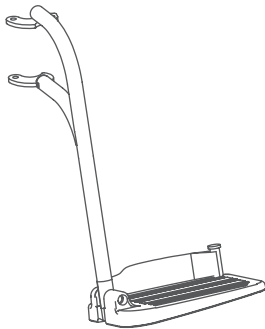

S310162 Replacement Part - Hero Premium Comfy Lite Legrest Assembly Right Side (Includes Footplate & Heel Strap)

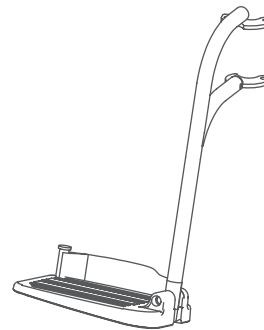

S310163 Replacement Part - Hero Premium Comfy Lite Legrest Assembly Left Side (Includes Footplate & Heel Strap)

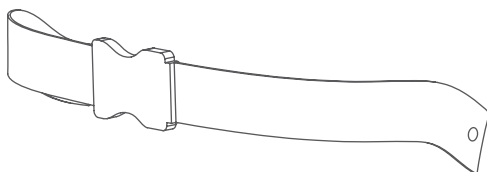

S327960 Replacement Part - Hero Medical Premium Comfy Lite And Super Budget Seat Belt Assembly

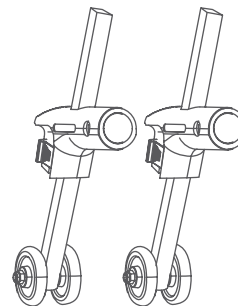

S310173 Replacement Part - Hero Premium Comfy Lite Height Adjustable Anti-Tippers Pair

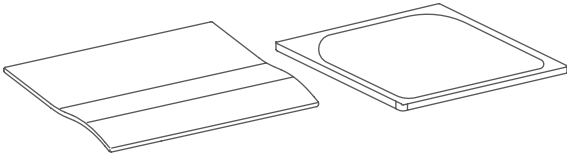

S310164 Replacement Part – Hero Premium Comfy Lite Seat Upholstery & Cushion For 16” Wheelchair Each

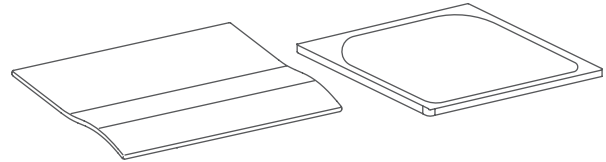

S310165 Replacement Part – Hero Premium Comfy Lite Seat Upholstery & Cushion For 18” Wheelchair Each

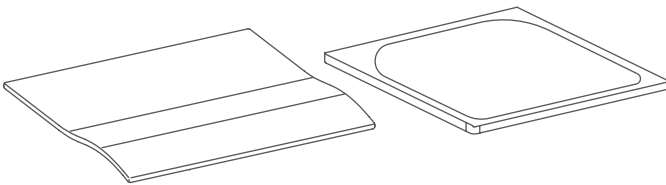

S310166 Replacement Part – Hero Premium Comfy Lite Seat Upholstery & Cushion For 19” Wheelchair Each

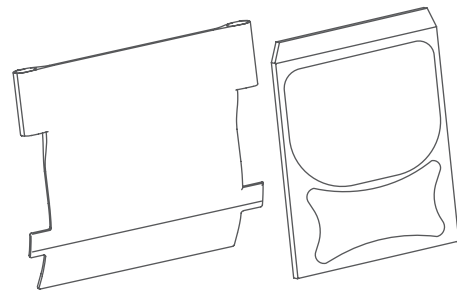

S310167 Replacement Part – Hero Premium Comfy Lite Back Upholstery & Cushion For 16” Wheelchair Each

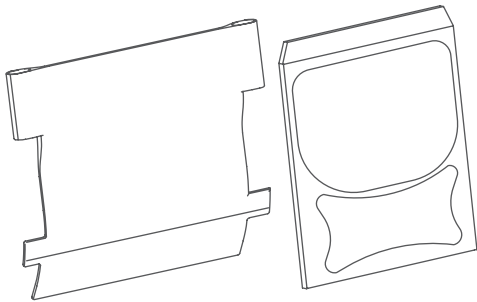

S310168 Replacement Part – Hero Premium Comfy Lite Back Upholstery & Cushion For 18” Wheelchair Each

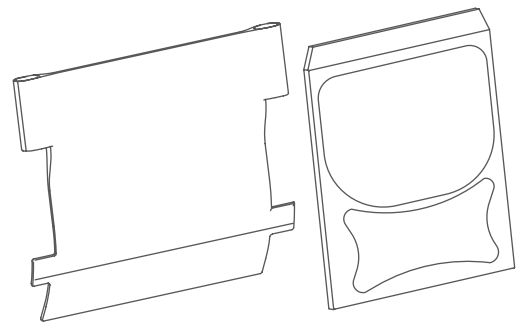

S310169 Replacement Part – Hero Premium Comfy Lite Back Upholstery & Cushion For 19” Wheelchair Each

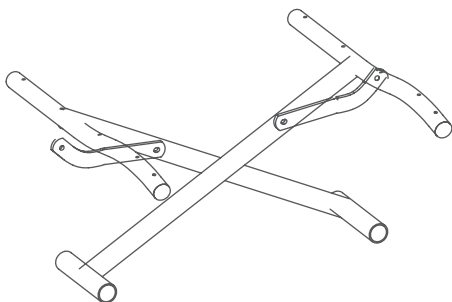

S310170 Replacement Part – Hero Premium Comfy Lite Frame Cross Brace Assembly For 16” Wheelchair

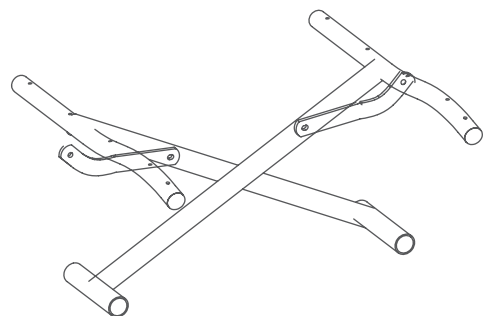

S310171 Replacement Part – Hero Premium Comfy Lite Frame Cross Brace Assembly For 18” Wheelchair

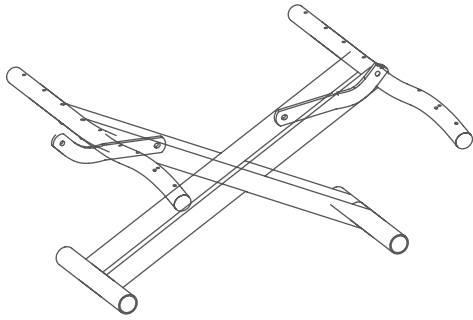

S310172 Replacement Part - Hero Premium Comfy Lite Frame Cross Brace Assembly For 19" Wheelchair

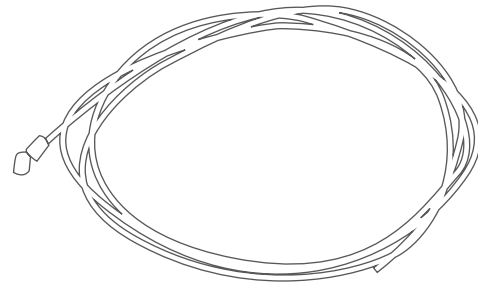

S328880 Replacement Part - Hero Medical Premium Comfy Lite Brake Cable For Self-Propelled (Universal Side) Each

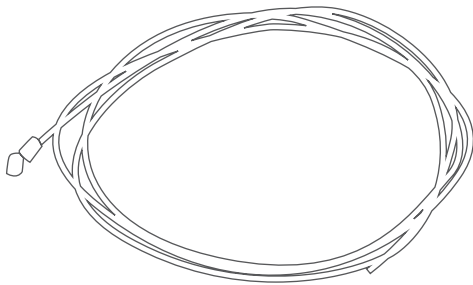

S328881 Replacement Part - Hero Medical Premium Comfy Lite Brake Cable For Transit (Universal Side) Each

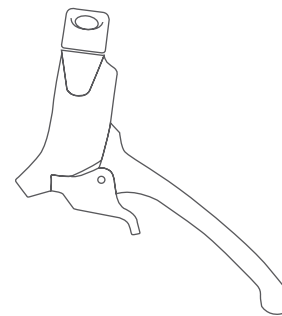

S328874 Replacement Part - Hero Medical Premium Comfy Lite Brake Handle For Transit And Self-Propelled (Universal Side) Each

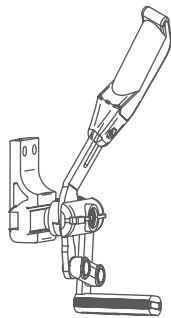

S328877 Replacement Part - Hero Medical Premium Comfy Lite Knee Brake Lever Set For Self-Propelled LHS Only Each

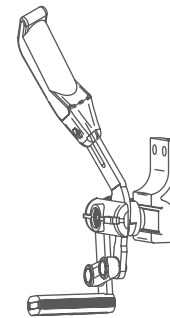

S328876 Replacement Part - Hero Medical Premium Comfy Lite Knee Brake Lever Set For Self-Propelled RHS Only Each

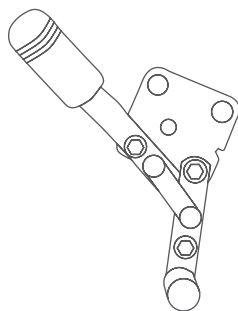

S328878 Replacement Part - Hero Medical Premium Comfy Lite Knee Brake Lever Set For Transit LHS Only Each

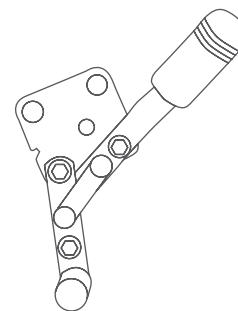

S328882 Replacement Part - Hero Medical Premium Comfy Lite Knee Brake Lever Set For Transit RHS Only Each
