



Hero Medical Euro Lite Seat Walker
User Manual

Contents

Section	Title	Page
1	Introduction	2
2	Safety & Precautions	3
3	Features	4
4	Specifications	4
5	Instructions For Use	5
6	Labelling Information	8
7	Product Care & Maintenance	9
8	Recycle & Disposal	9
9	Warranty	10

No part of this user manual may be copied, distributed, reproduced, duplicated, scanned or stored whether in whole or part in any form or by any means without the expressed written consent from the officers of Independent Living Specialists Pty Ltd. Independent Living Specialists does not accept responsibility for any changes, errors or omissions. All information is subject to change without prior notice and products may vary from that of the actual images depicted.

1 Introduction



S322126 Seat Walker - Euro Lite Aluminium Low Hero Medical 130kg SWL
 S310066 Seat Walker - Euro Lite Aluminium Standard Hero Medical 130kg SWL
 S310834 Seat Walker - Euro Lite Aluminium Tall Hero Medical 130kg SWL
 S322125 Seat Walker - Euro Lite Carbon Fibre (5kg Frame Weight) Low Hero Medical 130kg SWL
 S310067 Seat Walker - Euro Lite Carbon Fibre (5kg Frame Weight) Standard Hero Medical 130kg SWL
 S310835 Seat Walker - Euro Lite Carbon Fibre (5kg Frame Weight) Tall Hero Medical 130kg SWL

2 Safety & Precautions

Weight Capacity

The maximum safety weight limit for the seat walker is 130kg and must not be exceeded. If the maximum safety weight limit is exceeded, this can increase the risk of damage to the seat walker and/or risk of serious injury to the user and others.

User Safety

To ensure user safety, it is highly recommended that the below safety checks are completed prior to each use of the seat walker:

- Brakes are functional
- Castors do not show signs of wear and tear
- Backrest, seat, hand grip, storage bag and other removable parts are properly attached to the seat walker

Note: Failure to complete the above safety checks may result in seat walker malfunction and has the potential to cause injury to the user and others.

Exposure to Weather

Avoid exposure to hot or cold temperatures for extended periods of time, as it can cause parts of the seat walker to become very hot or cold. This can result in an increased risk of damage to the seat walker and/or risk of injury to the user and others.

Uneven Terrain

Operating the seat walker on uneven terrain increases the risk of the seat walker tipping over. Only operate on even and solid surfaces.

Intended Use

The seat walker is designed to be used as a walking aid. Before sitting on the seat walker, please apply brakes and ensure it is on even ground.

3 Features

- ▶ Lightweight
- ▶ Storage bag with carry handles
- ▶ Ergonomic, height-adjustable handles
- ▶ Folds easily for transportation and compact storage
- ▶ Large front castors for easy maneuvering and stability

4 Specifications

Name	Aluminium Low	Carbon Fibre Low	Aluminium Standard	Carbon Fibre Standard	Aluminium Tall	Carbon Fibre Tall
SKU	S322126	S322125	S310066	S310067	S310834	S310835
Frame material	Aluminium	Carbon Fibre	Aluminium	Carbon Fibre	Aluminium	Carbon Fibre
Size	Low	Low	Standard	Standard	Tall	Tall
Frame weight	6.4kg	5.2kg	6.6kg	5.3kg	6.8kg	5.4kg
Gross weight	7.8kg	6.6kg	8kg	6.7kg	8.2kg	6.8kg
Seat height (seat to floor)	50cm	50cm	57cm	57cm	63cm	63cm
Overall height (floor to handles)	66-84cm	66-84cm	73-90cm	73-90cm	77-96cm	77-96cm
Seat width	45cm	45cm	45cm	45cm	45cm	45cm
Outer width (including rear castors)	59cm	60.5cm	59cm	60.5cm	59cm	60.5cm
Front castor size	9"	9"	9"	9"	9"	9"
Rear castor size	9"	9"	9"	9"	9"	9"
Safe work load (SWL)	130kg	130kg	130kg	130kg	130kg	130kg

Instructions for Use 5

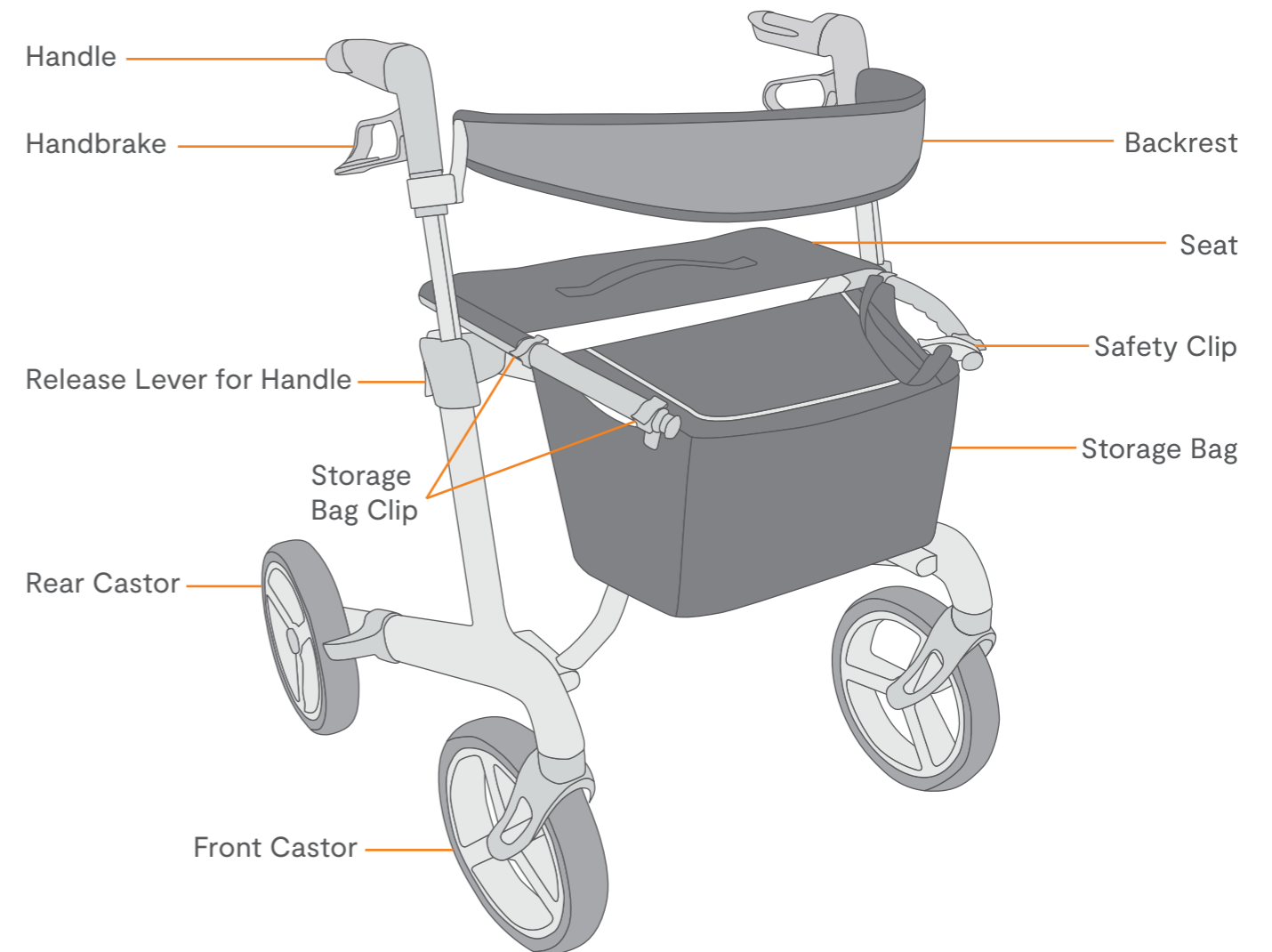

Unfolding the Seat Walker

- Unclip the safety clip located above the storage bag.
- Pull the handles apart until the frame is half open.
- Place hands flat on the top of the seat and push downwards to fully unfold the seat walker.

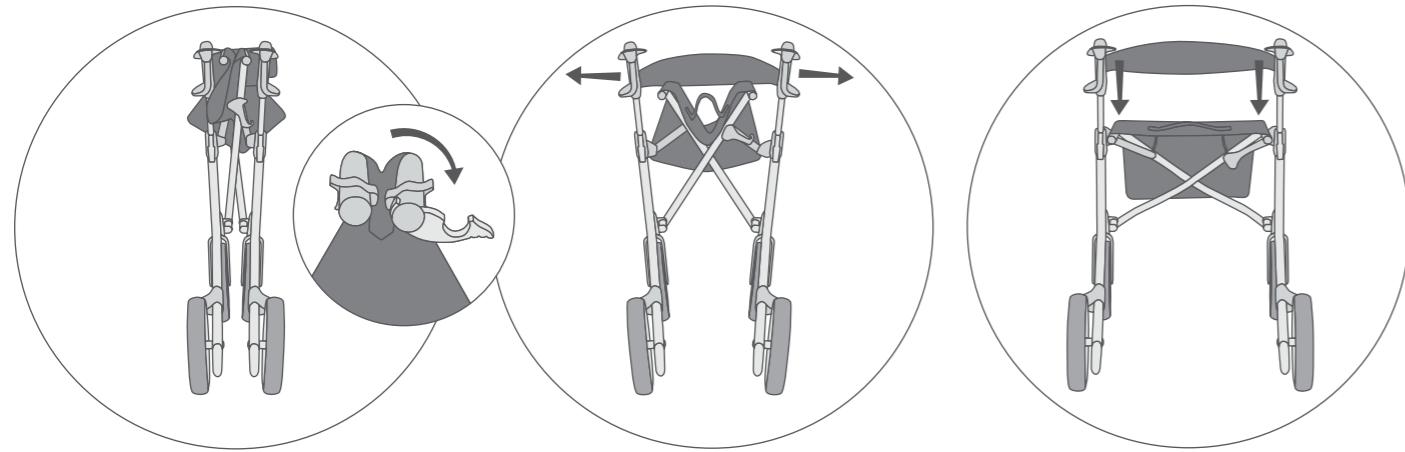

Adjusting the Handle Height

- Pull the white clip to unlock the handle.
- Pull or push the handles to reach desired height.

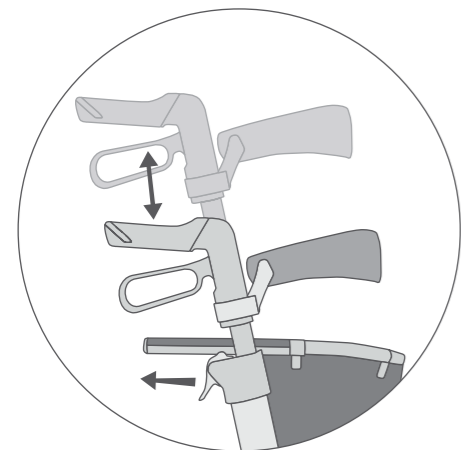

Attaching and Removing the Storage Bag

- Push the clips of the storage bag onto the pole located at the front end of the seat.
- Pull the clips to remove the storage bag.

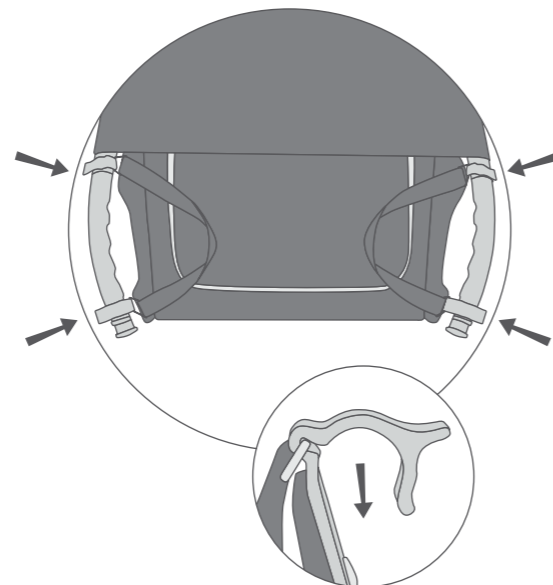

Using the Brakes

The seat walker features handbrakes with an integrated locking function to provide optimal control and safety for the user.

- To apply the brakes when in motion, pull the handbrake lever towards the handle and release to disengage brakes.
- To lock the brakes when the seat walker is parked, push the handbrake lever down until it locks. To release the brakes, pull the handbrake lever towards the handle.
- To adjust the tension of the brakes, tighten or loosen the tension adjustment nut (located at the end of the brake cable above the rear wheels). Adjusting the tensions of the brakes ensures the safe operation of the brakes when in use.

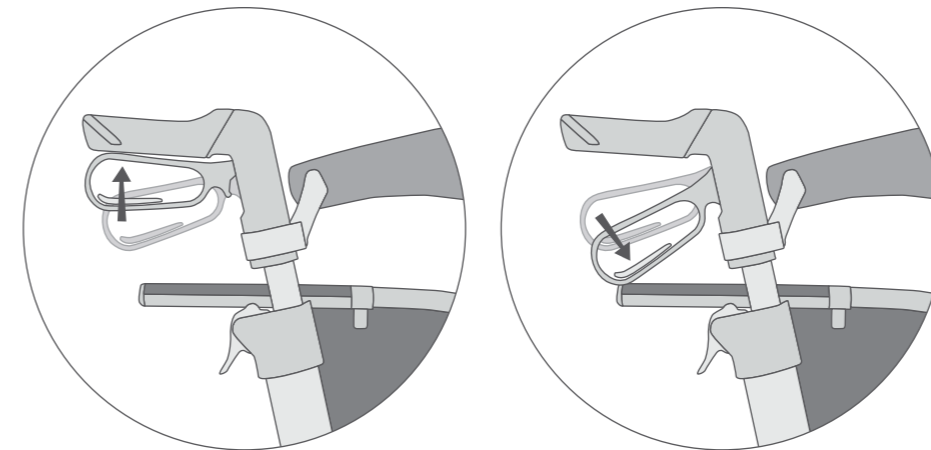

Folding the Seat Walker

- Pull the strap located in the middle of the seat upwards to unlock the frame.
- Push both of the handles inwards to fully collapse the seat walker.
- Clip the black safety clip onto the seat frame to lock the folded seat walker in place.

6 Labelling Information

a. Product Label

The seat walker has a product label on the frame, located above the rear right castor. The product label includes the following information:

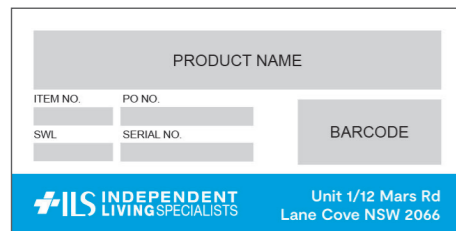

- Name and address of the company
- Name and code for the product
- Safe Working Load (SWL)
- Serial number of the product (which includes the date of manufacture and the batch serial number)

b. Usage Label

The seat walker has a usage label on the frame, located above the rear left castor. The usage label includes the following information:

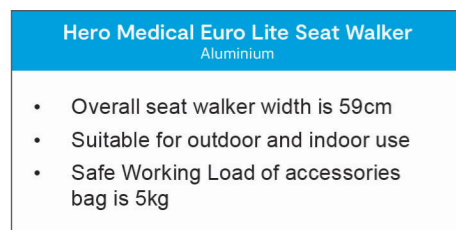

Label for aluminium product variations:
S322126, S310066 & S310834

- Overall seat walker width is 59cm
- Suitable for outdoor and indoor use
- Safe Working Load of accessories bag is 5kg

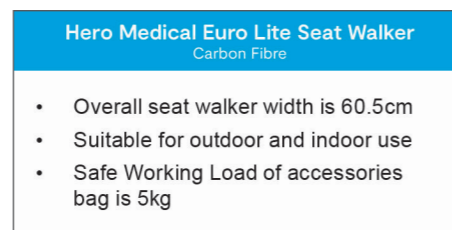

Label for carbon fibre product variations:
S322125, S310067 & S310835

- Overall seat walker width is 60.5cm
- Suitable for outdoor and indoor use
- Safe Working Load of accessories bag is 5kg

Product Care & Maintenance 7

- It is recommended that the seat walker is inspected every 3 months for signs of wear and tear of the castors, seat or backrest.
- If there are visible signs of wear and tear, please contact your authorised dealer for replacement parts.
- Please ensure the brakes are tested prior to each use.
- If exposed to water or moisture, promptly dry the seat walker to prevent corrosion of the frame.
- The seat walker should be wiped down regularly using warm water or a mild detergent.
- All replacement parts as well as after-sales support and repair services are available through Hero Medical dealers.

Recycle & Disposal 8

Please follow the local government rules in regards to proper recycling and disposal. It should always be done through an authorised agent or licensed place of disposal. Please review the list of seat walker parts and packaging materials to ensure they are recycled or disposed of correctly.

- Frame: tubular aluminium or carbon fibre frame
- Seat & Backrest: vinyl & nylon
- Castors and handgrips: polyurethane
- Packaging: cardboard box and plastic

9 Warranty

The Hero Medical Euro Lite seat walker comes with 12 months warranty from the date of purchase on structural integrity.

- During the warranty period any parts that have become defective due to faulty workmanship or material will be repaired or replaced without charge by a Hero Medical dealer of where the product was purchased.
- The warranty excludes castors, components and parts that are subject to reasonable wear and tear.
- The warranty excludes faults that have been identified as misuse or user error.
- Unauthorized changes or modifications will forfeit your warranty.
- If a defect or fault is discovered, the Hero Medical dealer of where the seat walker was purchased should be contacted immediately.



Independent Living Specialists
Unit 1, 12 Mars Road
Lane Cove West NSW 2066
1300 008 267 | ilsau.com.au

©2023 HERO MEDICAL. INDEPENDENT LIVING SPECIALISTS

PDT023-0723